

AZZA
ONE VISION. ONE MISSION



1X
USB 3.0

UP TO
5X
120mm FAN

UP TO
340
mm
VGA CARD

USER MANUAL

FORUM
AZZA

AZZA
ONE VISION. ONE MISSION

1. Specifications
2. Chassis Parts
3. Control Panel Functions / ODD installation
4. 3.5"/2.5" HDD Installation
5. Cooling System Installation

Specifications

Model	
Model Name	GOLEM 221
Model Number	CSAZ-221 / CSAZ-221G
Specs	
Type	ATX Mid-Tower
Color	Black (exterior)/Black (interior)
Side Panel Window	CSAZ-221-Flat transparent side acrylic panel CSAZ-221G-Tempered glass with rubber mounts
Max CPU Cooler Height	Up to 155 mm
With Power Supply	No
Motherboard Compatibility	ATX Micro ATX
Expansion	
External 5.25" Drive Bays	1 (If an ODD is installed, then the length of the motherboard cannot exceed 229mm)
Internal 2.5" Drive Bays	3
Internal 3.5" Drive Bays	3
Expansion slots	7
Front Ports	
	1 x USB 3.0, 1 x USB 2.0, HD Audio, Mic.
Cooling System	
120mm Fan	2x120mm Red LED fan in front
Physical Specs	
Dimensions(HxWxD)	480x197x427mm / 18,9x7,8x16,8 inches
Weight	9.0 lbs (4.0 Kg)
Features	
Max VGA card length	Support up to 340mm long VGA card.
Transparent Side Window	High-quality transparent side window allows for clear visuals to inner components.
Supports Water Cooling	Supports 120mm/240mm water cooling radiator
Isolated Chamber	Power supply is isolated in its own chamber, preventing its heat from affecting other components.
Cable Management	Cables are hidden behind the pre-drilled motherboard tray; better cable management means better air flow
Easy installation of CPU Cooler	A pre-cut hole for easy installation of CPU cooler,eliminating the need to remove the motherboard

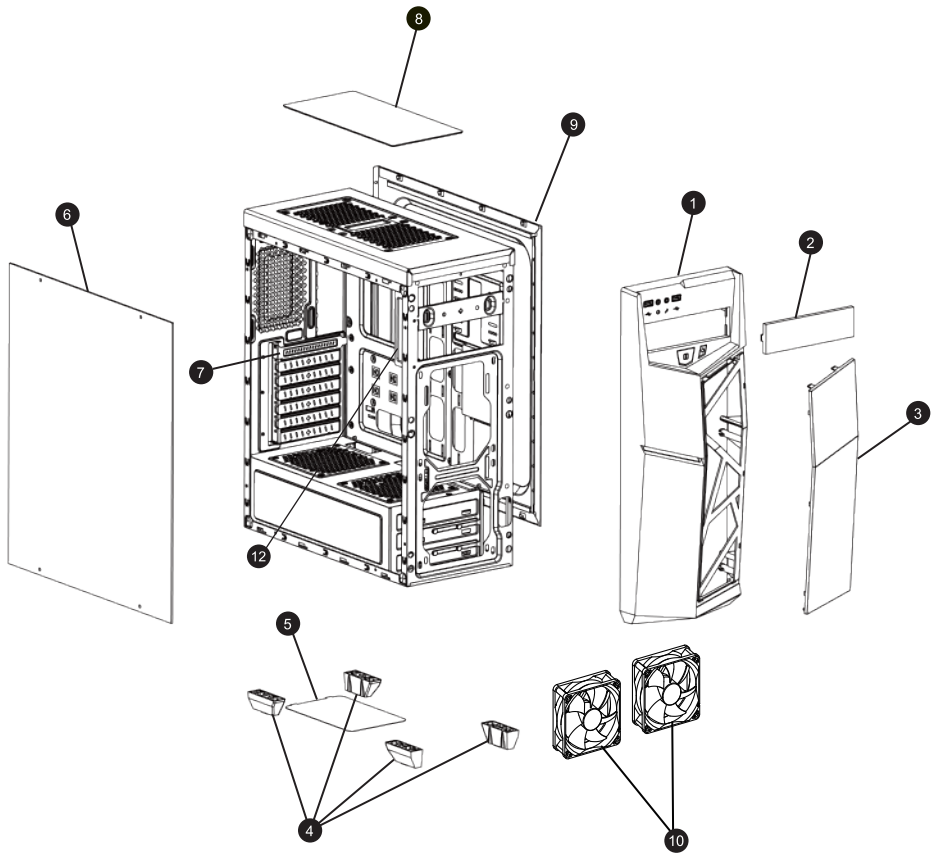

Chassis parts





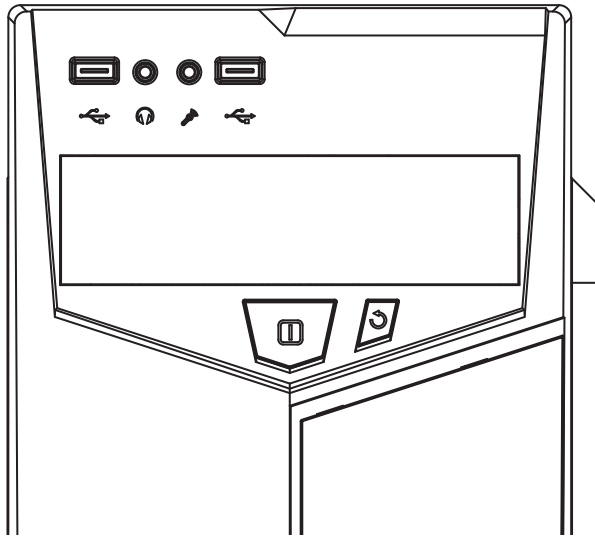

1	Front bezel
2	5.25" Device Cover ×1
3	Acrylic cover
4	Stand ×4
5	Dust filter
6	Acrylic left side panel
7	PCI slot cover
8	PVC dust filter with magnet
9	Right side panel
10	120mm Fan X2
12	ODD tray

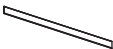
Control panel functions



	Power
	Reset
	Power LED

	USB3.0(Blue)
	USB2.0(Black)
	Mic
	Audio

ODD installation

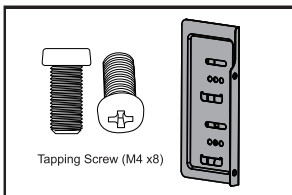

Tapping Screw (M4 x8)

Prepare the ODD tray and tapping screws (M4x8). These can be found in the parts package.

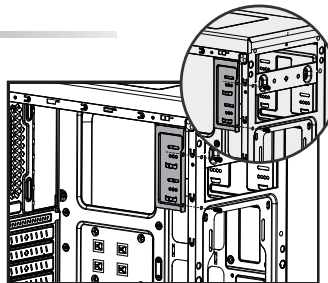

Install ODD tray.

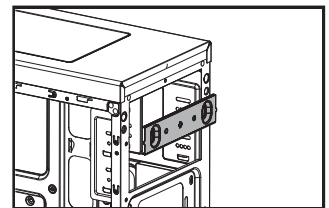

Remove 5.25" metal cover.

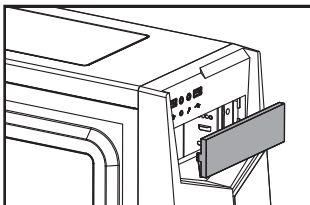

Take out drive cover.

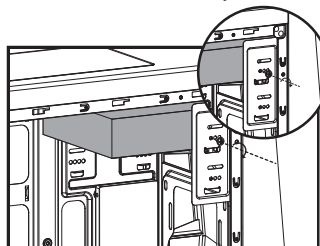

Secure ODD drive.

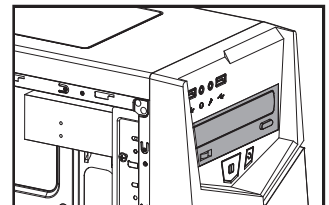

Insert ODD drive.

3.5" / 2.5" HDD Installation

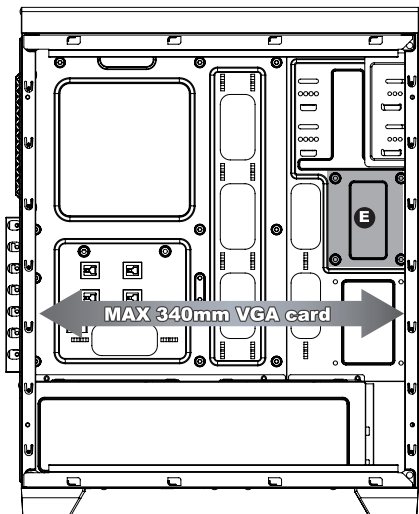

- Supports up to 340mm long video cards.



or

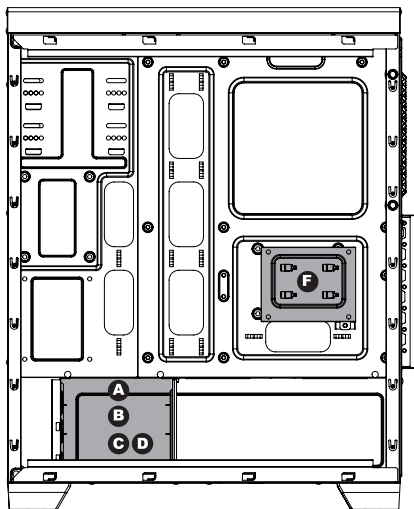

- Supports 3.5" HDD X3 (A B C)
- Supports 2.5" Devices X3 (D E F)

Cooling System Installation

Front

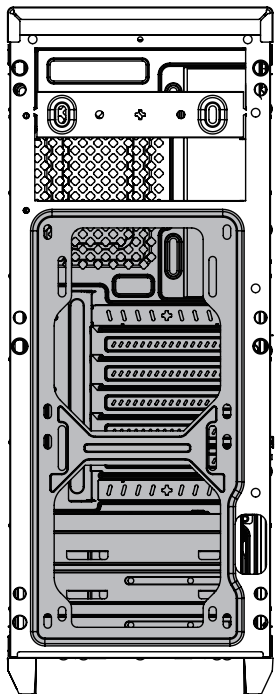

120mm x 2

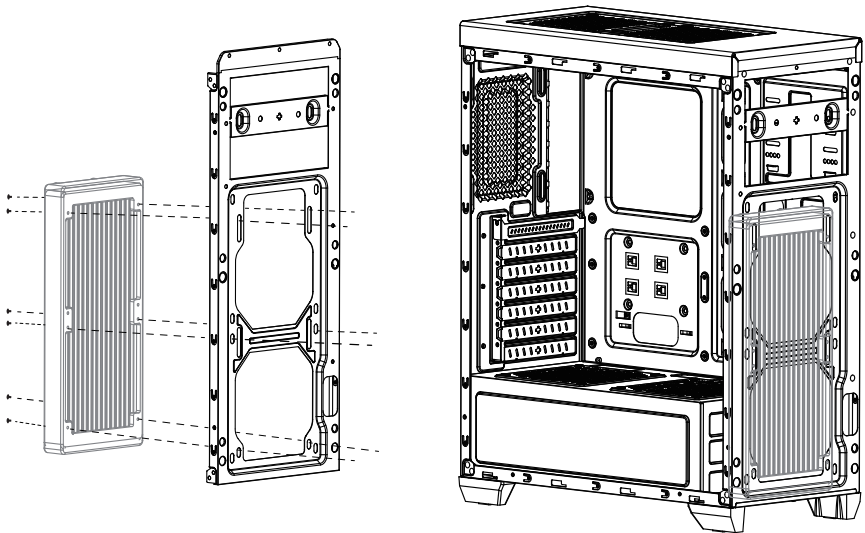

Cooling System Installation

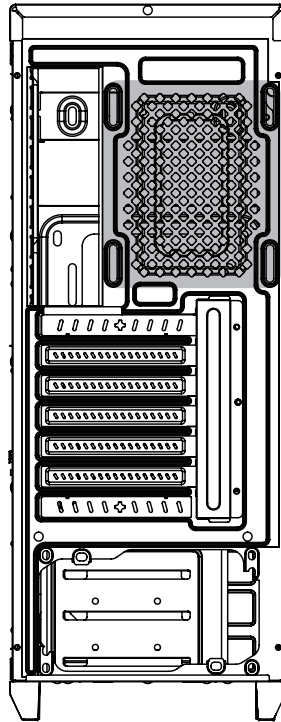

Rear

120mm x1

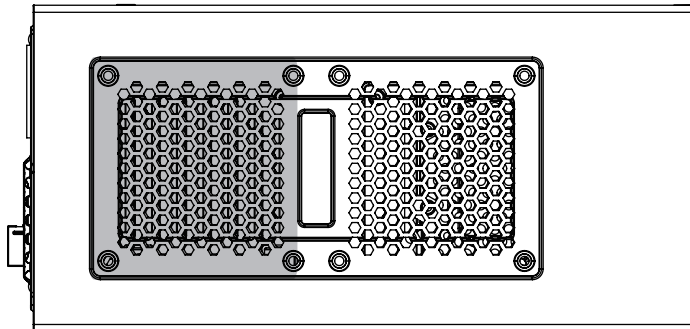
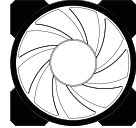

Top

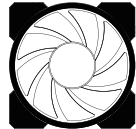

120mm x2

AZZA
ONE VISION. ONE MISSION

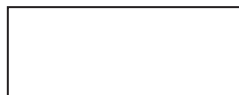

Made in China