



BASTION 120

USER MANUAL

www.azzatek.com

1. Specifications
2. Chassis Parts
3. Control Panel Functions
4. 3.5"/2.5" HDD/SSD Installation
5. Cooling System Installation

Specifications

Model	
Model Name	Bastion 120
Model Number	CSAZ-120
Specifications	
Type	Micro ATX Mid Tower
Color	Black/Black(interior)
Side Panel Window	Left Side panel: Magnetic Tempered Glass Door
Max CPU Cooler Height	UP to 175mm
Max Video Card Length	Up to 340mm long video card
Power Supply	Not Included
Motherboard Compatibility	Micro ATX · ITX
Expansion	
External 5.25" Drive Bays	0
Internal 2.5" Drive Bays	Up to 4
Internal 3.5" Drive Bays	Up to 2
Expansion Slots	4
Top Ports	Power button, reset button, Led button, HD Audio, USB 3.0 x 1, USB2.0x2
Physical Specifications	
Dimensions (HxWxD)	390x230x400mm/15.4x9.1x15.7 inches
Weight	4.2kg /9.26lbs
Features	
Tempered Glass Side Window	High-quality tempered glass side window allows for clear visuals to inner components
Available Fan Ports	2x120mm or 2x140mm or 1x200mm Fan ports in the front 2x120mm or 2x140mm Fan ports on the top 1x120mm or 1x140mm Fan port in the rear (1x140mm Fan included for model CSAZ-120)
Water Cooling	Supports radiator up to 240/280mm in the Front Supports radiator up to 240mm on the Top
Dust Filters	Removable (magnetic) dustproof net on the top , iron net on bottom of chassis.
Power Supply Support	Bottom mounted ATX Power Supply



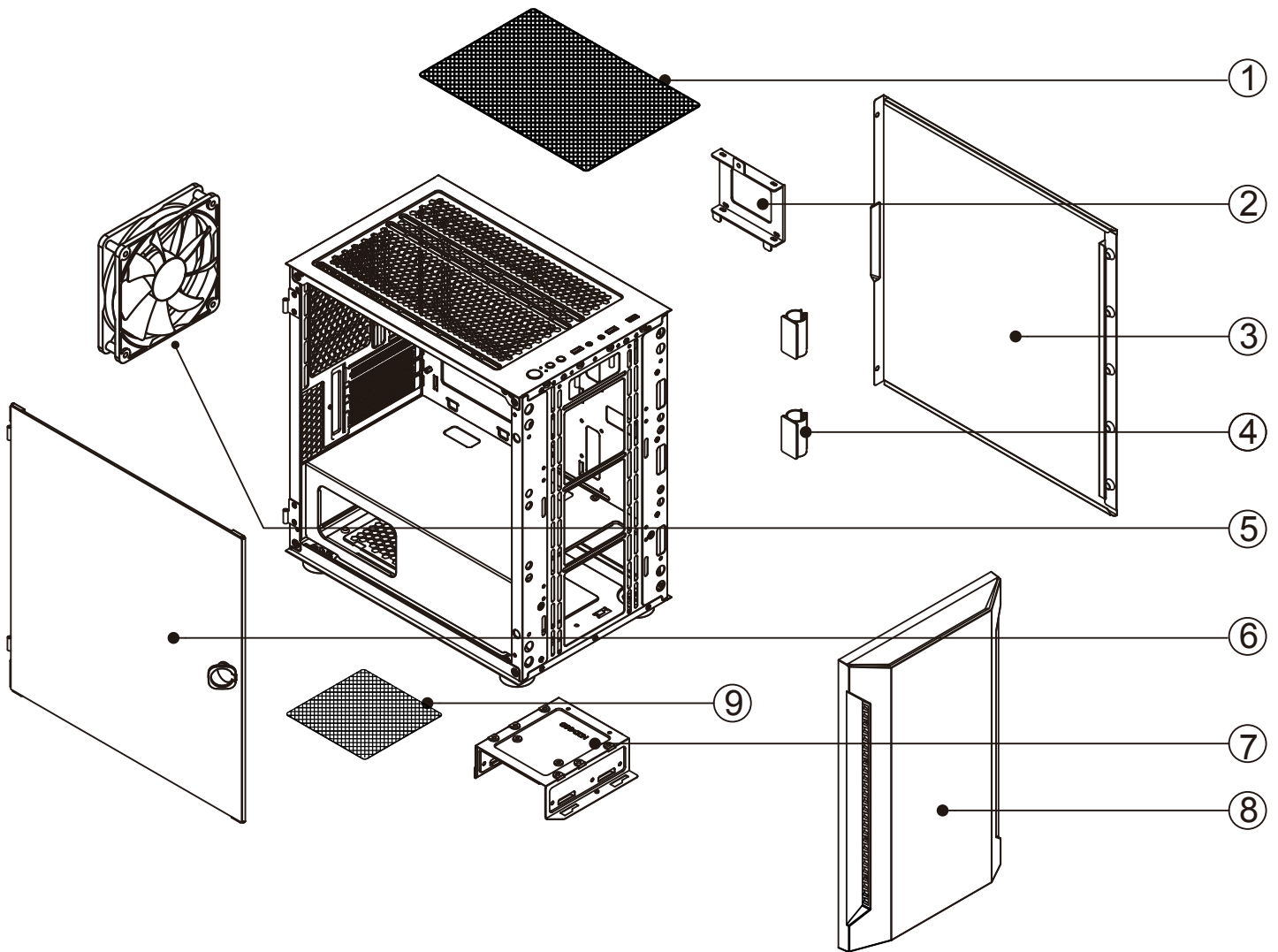

Chassis Parts



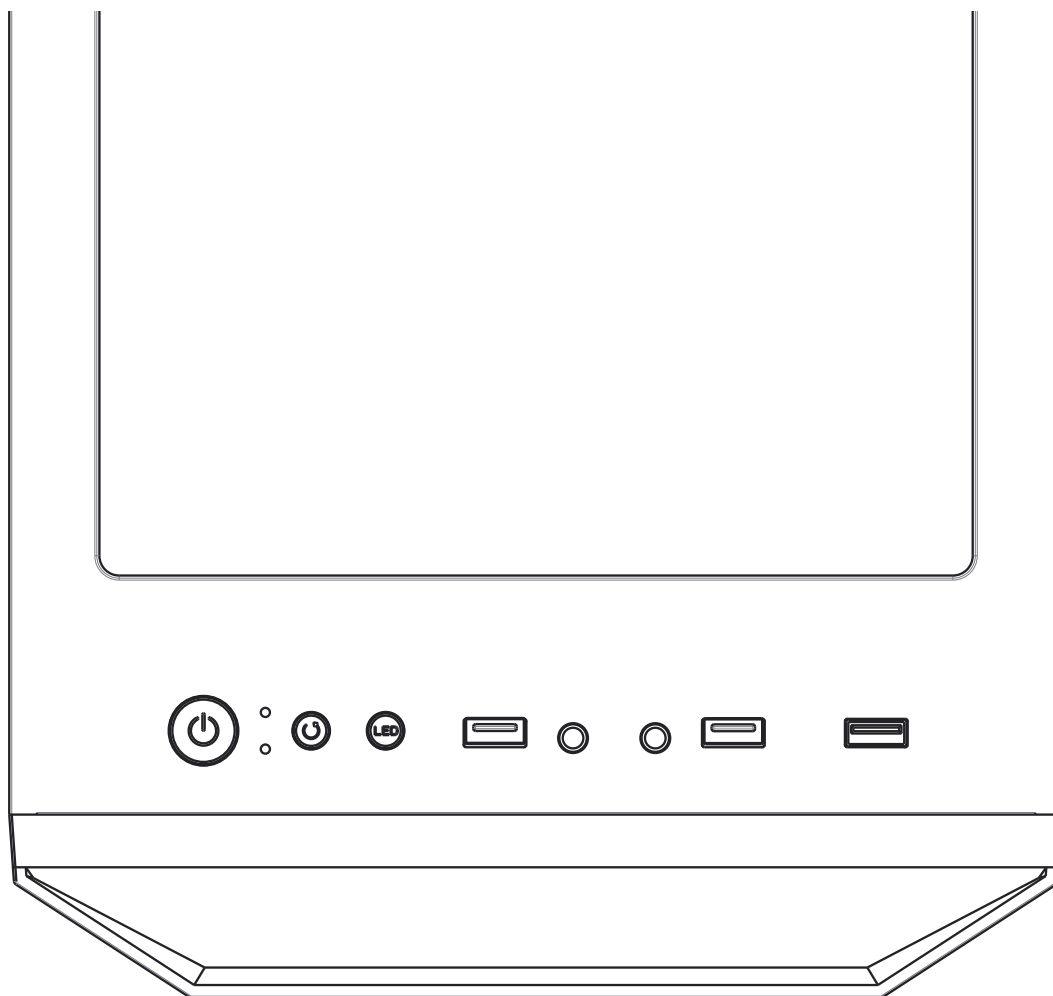

1	Removable (magnetic) dustproof mesh
2	SSD tray
3	Right side panel
4	Cable clip
5	14cm fan x1
6	Left magnetic tempered glass door
7	HDD tray
8	Front panel
9	iron mesh

Control Panel Functions



	POWER
	RESET
	LED
	Audio

	USB 3.0 (Blue)
	USB 2.0 (Black)
	Mic

3.5" / 2.5" HDD/SDD Installation

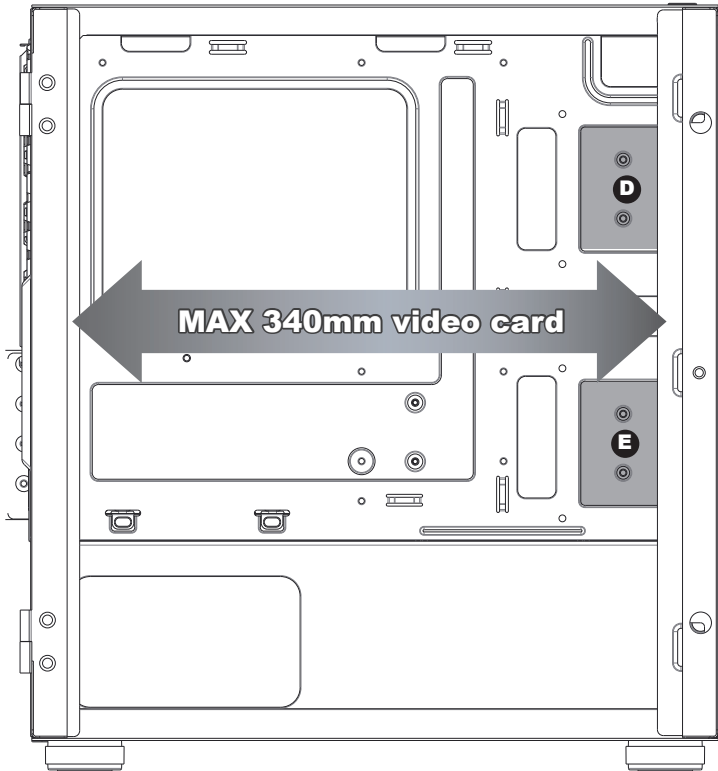

▪ Supports up to 340mm long video cards.



or

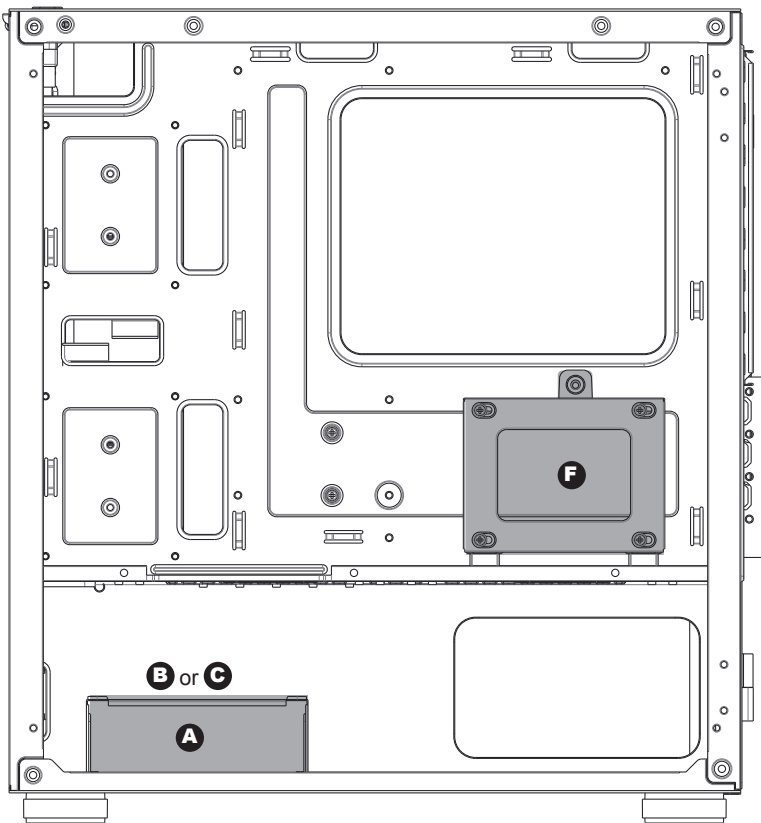
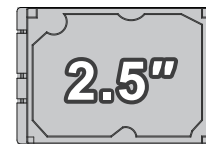

▪ Supports 3.5" HDD X2 (**A** **B**)

▪ Supports 2.5" SSD X4 (**C** **D** **E** **F**)

Front

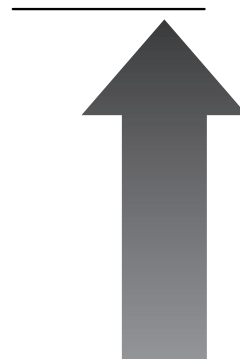
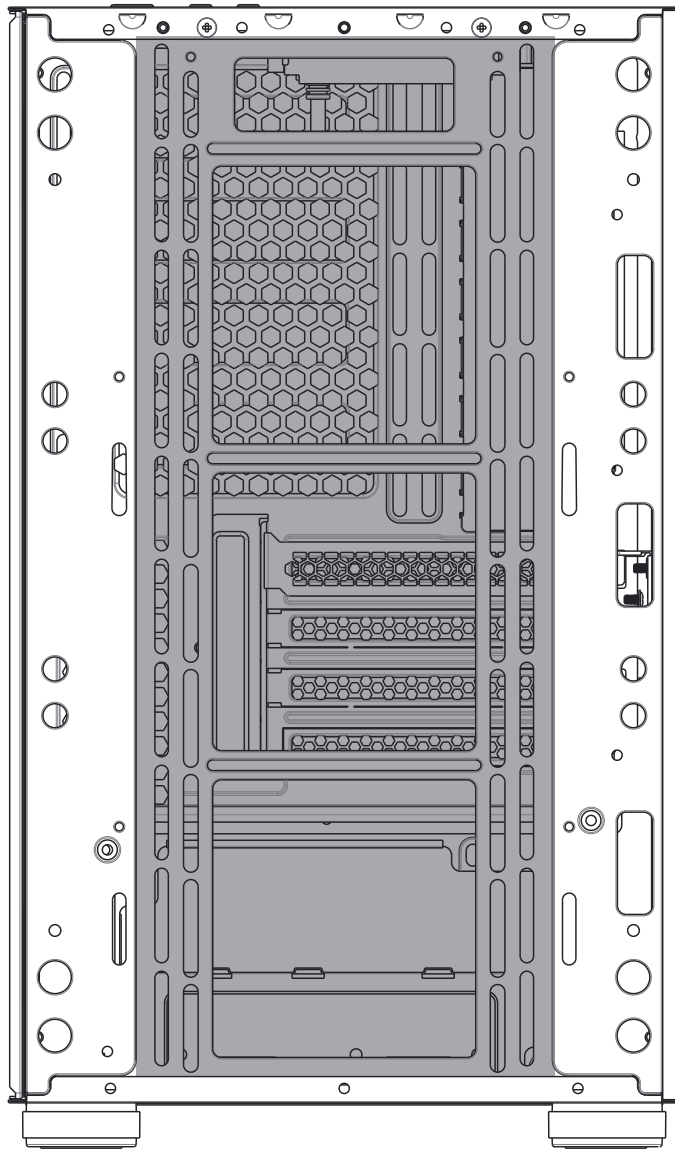

Max Height of
Radiator
280 mm

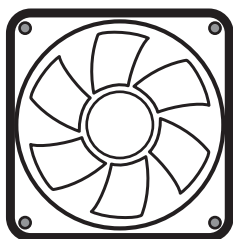

120mm x2

or

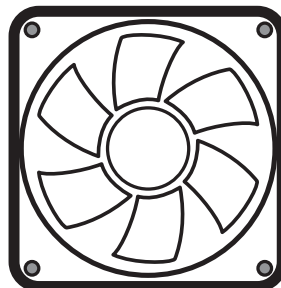

140mm x2

Front

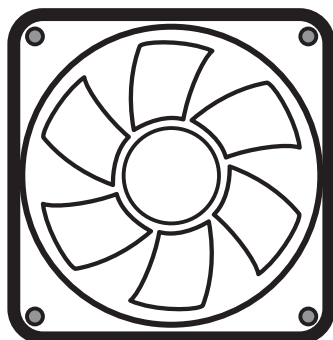
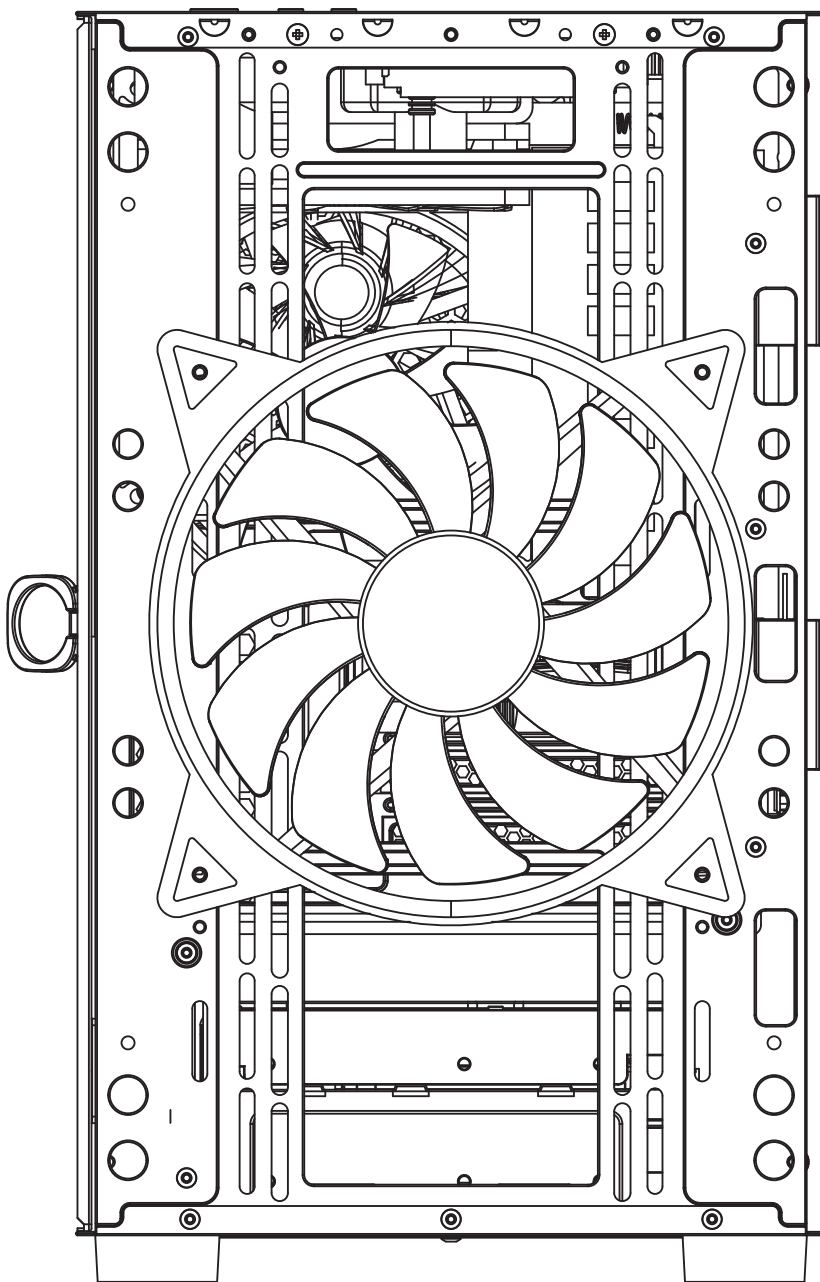

200mm x1

Rear

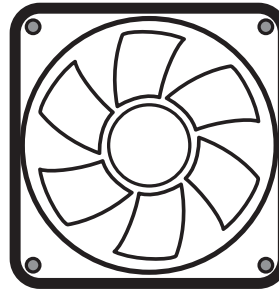
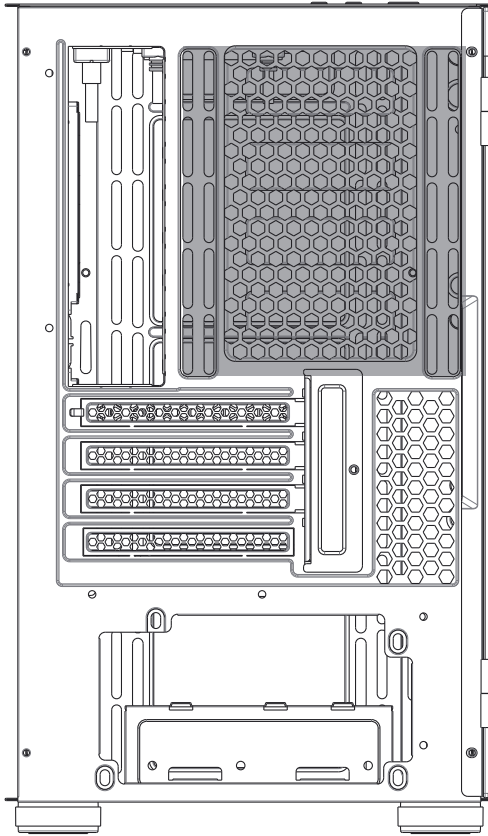

140mm x1

or

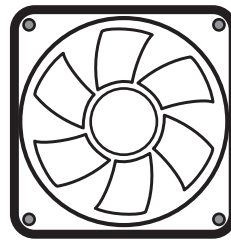

120mm x1

Top

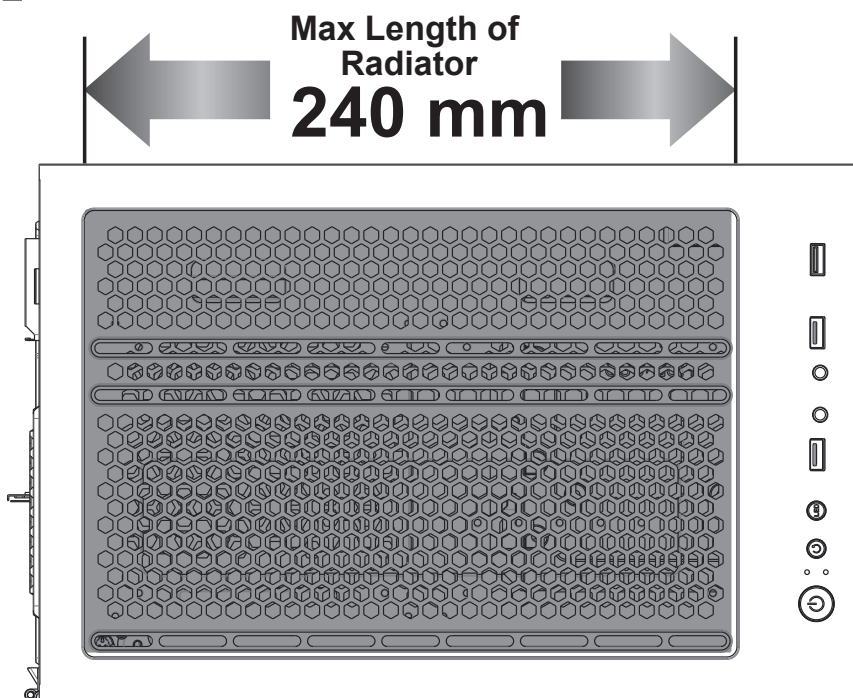

Max Length of
Radiator

240 mm

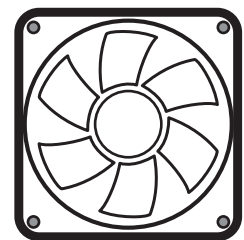

120mm x2

or

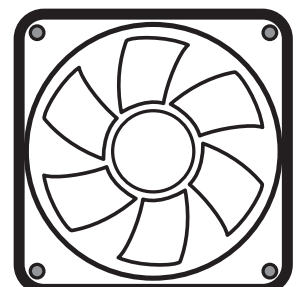

140mm x2

